

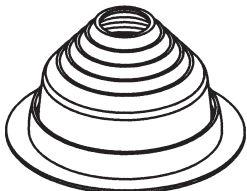





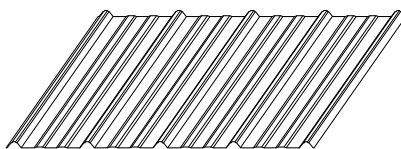

## ACCESSORIES

<p>RUBBER PIPE FLASHING • FLASHERS • BLACK EPDM</p> 	SIZE	PIPE SIZE	TEMP. RANGE	BASE	WT./EA.	PRICE EACH
	EPDM					
	#1	¼" - 2"	-65° to 250°	4-¾"	0.2#	13.95
	#3	¼" - 5"	-65° to 250°	7-¾"	0.45#	19.80
	#5	4-¼" - 7-½"	-65° to 250°	10-¾"	1.0#	33.60
	#7	6" - 11"	-65° to 250°	14-¼"	2.0#	67.95
#8	7" - 13"	-65° to 250°	16-½"	2.3#	99.00	
<p>TOUCH-UP PAINT</p> 	DESCRIPTION					PRICE EACH
	<p>Valspar Matching Color, Panel Touch Up Paint 2 oz. Bottle</p> <p style="text-align: right;">Silicone Polyester</p>					16.25
<p>LIGHT TRANSMITTING PANELS</p> 	TYPE	COLOR	LENGTH	WT./EA.	PRICE Each	
	SBS 369 (Non-Reinforced)	White	10'-0"	10.5#	53.15	
<p>WARNING: This light transmitting panel is not designed or intended to bear any weight of a person standing, sitting, walking or resting on them.</p>						
<p>SBS 369 CLOSURE STRIP</p> <p>Each Piece 3'-0"</p> 	DESCRIPTION				WT./100	PRICE EACH
	Inside				4.0#	.85
	Outside				6.2#	.85
<p>TAPE SEAL</p>   <p style="text-align: center;">Flat</p>	SIZE	CARTON QTY	ROLL WT./EA.	PRICE EACH		
	¾" x ¾" x 45'	40	1.5#	3.05		
	1" x ¾" x 45'	20	3.3#	7.00		
<p>TUBE CAULKING</p>  <p>10.3 oz. cartridge.</p>	TYPE	COLOR	TUBE SIZE	CARTON QTY,	TUBE WT./EA.	PRICE EACH
	Polyurethane	White	10.3 oz	30	1.2#	7.25
	Polyurethane	Gray	10.3 oz	30	1.2#	7.25
	Polyurethane	Bronze	10.3 oz	30	1.2#	7.25
	Polyurethane	Almond	10.3 oz	30	1.2#	7.25
	Silicone	Clear	10.3 oz	30	1.2#	8.75

## ACCESSORIES

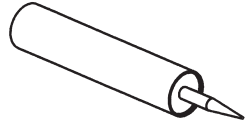
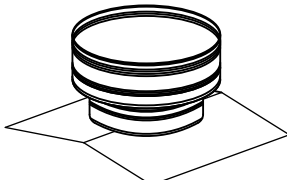
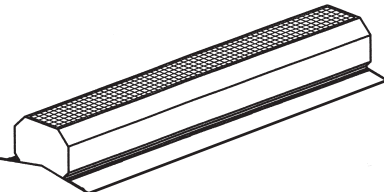
	DESCRIPTION	WT./EA.	PRICE EACH	
			GALVALUME®	WHITE
<p>CIRCULAR GRAVITY VENTILATORS</p> 	20" Diameter Throat, 26 GA, w/ damper	70.0#	325.00	330.75
	24" Diameter Throat, 26 GA, w/ damper	70.0#	477.70	487.25
<p>All ventilators have bird screen and damper. Pricing shown is for ventilators with flat base only. For standard color ventilators other than White, please inquire. For chain operated ventilators, please inquire.</p>				
	DESCRIPTION	WT./EA.	PRICE EACH	
			GALVALUME®	WHITE
<p>CONTINUOUS THROAT GRAVITY RIDGE VENTILATORS</p> 	9" Throat x 10' Long, 26 GA, w/ damper	207.0#	526.70	568.50
	12" Throat x 10' Long, 26 GA, w/ damper	223.0#	656.40	706.85
<p>All ventilators have bird screen and damper. Pricing shown is for ventilators with flat skirts only. Included with each ventilator are splice plates, end skirts, and special rope sealant. All ventilators will conform to roof slopes up to 6:12. For standard color ventilators other than Polar White, please inquire. For chain operated ventilators, please inquire.</p>				
	DESCRIPTION.	PRICE EACH		
<p>VENTILATOR HARDWARE</p> 	Galvanized 3/16" Vent Cable		.42	
	Vent Pulley		4.75	
	1/4" x 2" Eye Bolt w/ Nuts		.45	
	Cable Clamps		.60	

## ACCESSORIES

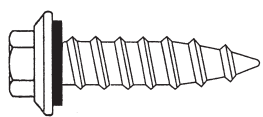
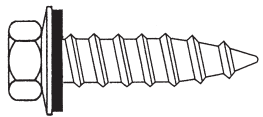
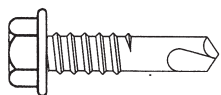
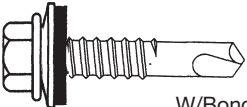
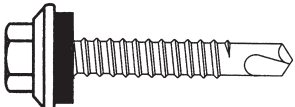
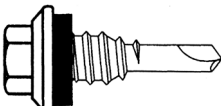
SELF-TAPPING CARBON STEEL FASTENERS	SIZE	LENGTH	TYPE	HEAD AF	WT./M	PRICE PER 1000		
							PLAIN	PAINTED
 <p>Holes must be pre-drilled through all metal when using this type of fastener</p>	#14	¾"	A	⅝"	13.2#	81.00	95.25	
	#14	1"	A	⅝"	17.0#	94.60	109.15	
	#14	1-½"	A	⅝"	21.0#	110.80	125.05	
	#17	1"	AB	⅝"	16.0#	158.25	172.50	
	Note: Fasteners sold in quantities of 250 only.							
304 STAINLESS STEEL SELF-TAPPING FASTENERS	SIZE	LENGTH	TYPE	HEAD AF	WT./M	PRICE PER 1000		
 <p>Holes must be pre-drilled through all metal when using this fastener. CAUTION: The threads on 304 SS fasteners are softer than carbon steel and will strip out if over-torqued or forced into too small a hole.</p>							PLAIN	PAINTED
	#14	¾"	A	⅜"	14.7#	244.75	259.00	
	#14	1"	A	⅜"	17.0#	281.85	296.10	
	#14	1½"	A	⅜"	21.4#	360.95	375.20	
	#17	1"	AB	⅜"	21.0#	373.90	388.15	
Note: Fasteners sold in quantities of 250 only.								
MINI-WAREHOUSE SELF-DRILLING CARBON STEEL FASTENERS	SIZE	LENGTH	TYPE	HEAD AF	WT./M	PRICE PER 1000		
 <p>No washer</p>							PLAIN	PAINTED
	#12	7/8"	DRILLER	⅝"	8.7#	74.55	88.80	
Note: Fasteners sold in quantities of 250 only.								
MINI-WAREHOUSE SELF-DRILLING CARBON STEEL FASTENERS	SIZE	LENGTH	TYPE	HEAD AF	WT./M	PRICE PER 1000		
 <p>W/Bonded Washer</p>							PLAIN	PAINTED
	#12	7/8"	DRILLER	⅝"	11.7#	92.15	106.40	
Note: Fasteners sold in quantities of 250 only.								
SELF-DRILLING CARBON STEEL FASTENERS	SIZE	LENGTH	TYPE	HEAD AF	WT./M	PRICE PER 1000		
 <p>For attaching sheet to Ceas and Zees.</p>							PLAIN	PAINTED
	#12	1-¼"	DRILLER	⅝"	16.2#	84.45	99.70	
	#12	1-½"	DRILLER	⅝"	17.1#	108.30	122.55	
	#12	2"	DRILLER	⅝"	20.0#	172.60	186.85	
Note: Fasteners sold in quantities of 250 only.								
SELF-DRILLING CARBON STEEL FASTENERS	SIZE	LENGTH	TYPE	HEAD AF	WT./M	PRICE PER 1000		
 <p>For attaching sheet to sheet.</p>							PLAIN	PAINTED
	#14	7/8"	LAPTEK	⅝"	12.6#	87.60	101.85	
Note: Fasteners sold in quantities of 250 only.								



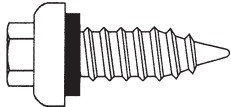
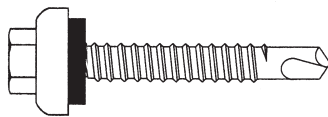
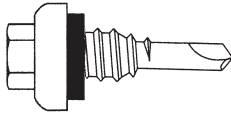
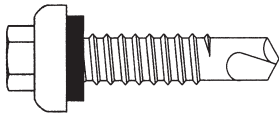
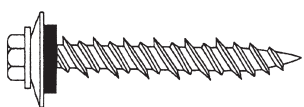
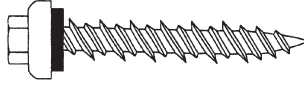
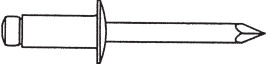

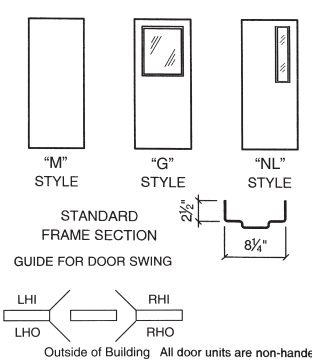
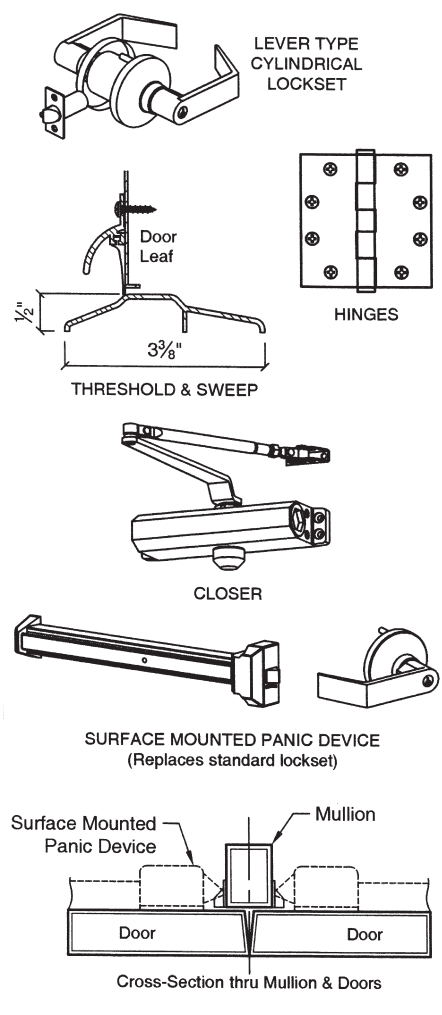

## ACCESSORIES

<p><b>LONG-LIFE SELF-TAPPING FASTENERS</b></p>  <p>Holes must be pre-drilled through all metal when using this type of fastener.</p>	<b>SIZE</b>	<b>LENGTH</b>	<b>TYPE</b>	<b>HEAD AF</b>	<b>WT./M</b>	<b>PRICE PER 1000</b>			
						<b>PLAIN</b>	<b>PAINTED</b>		
	<p>#14      1"      AB      5/16"</p> <p>#17      1"      AB      5/16"</p> <p>Note: Fasteners sold in quantities of 250 only.</p>	17.9#	18.0#	232.70	246.20	270.20	283.70		
<p><b>LONG-LIFE SELF-DRILLING FASTENERS</b></p>  <p>For attaching sheet to Cees and Zees.</p> <p>Note: Fasteners sold in quantities of 250 only.</p>	<b>SIZE</b>	<b>LENGTH</b>	<b>TYPE</b>	<b>HEAD AF</b>	<b>WT./M</b>	<b>PRICE PER 1000</b>			
						<b>PLAIN</b>	<b>PAINTED</b>		
	<p>#12      1-1/4"      DRILLER      5/16"</p> <p>#12      1-1/2"      DRILLER      5/16"</p> <p>#12      2"      DRILLER      5/16"</p> <p>Note: Fasteners sold in quantities of 250 only.</p>	18.1#	19.2#	20.7#	177.50	217.25	279.60	190.95	230.75
<p><b>LONG-LIFE SELF-DRILLING FASTENERS</b></p>  <p>For attaching sheet to sheet.</p> <p>Note: Fasteners sold in quantities of 250 only.</p>	<b>SIZE</b>	<b>LENGTH</b>	<b>TYPE</b>	<b>HEAD AF</b>	<b>WT./M</b>	<b>PRICE PER 1000</b>			
						<b>PLAIN</b>	<b>PAINTED</b>		
	<p>#14      7/8"      LAPTEK      5/16"</p> <p>Note: Fasteners sold in quantities of 250 only.</p>	17.2#	179.50	193.00					
<p><b>LONG-LIFE SELF-DRILLING FASTENERS</b></p>  <p>For attaching sheet to Cees and Zees.</p> <p>Note: Fasteners sold in quantities of 250 only.</p>	<b>SIZE</b>	<b>LENGTH</b>	<b>TYPE</b>	<b>HEAD AF</b>	<b>WT./M</b>	<b>PRICE PER 1000</b>			
						<b>PLAIN</b>	<b>PAINTED</b>		
	<p>#14      1-1/4"      DRILLER      5/16"</p> <p>Note: Fasteners sold in quantities of 250 only.</p>	19.2#	243.10	256.60					
<p><b>METAL TO WOOD FASTENERS</b></p>  <p>For attaching steel sheeting to a wood frame or wood decking</p> <p>Note: Fasteners sold in quantities of 250 only.</p>	<b>SIZE</b>	<b>LENGTH</b>	<b>TYPE</b>	<b>HEAD AF</b>	<b>WT./M</b>	<b>PRICE PER 1000</b>			
						<b>PLAIN</b>	<b>PAINTED</b>		
	<p>#10      1"      WOODGRIP      1/4"</p> <p>#10      1-1/2"      WOODGRIP      1/4"</p> <p>#10      2"      WOODGRIP      1/4"</p> <p>Note: Fasteners sold in quantities of 250 only.</p>	8.2#	10.5#	12.3#	45.40	56.55	66.00	59.65	70.80
<p><b>LONG-LIFE METAL TO WOOD FASTENERS</b></p>  <p>For attaching steel sheeting to a wood frame or wood decking</p> <p>Note: Fasteners sold in quantities of 250 only.</p>	<b>SIZE</b>	<b>LENGTH</b>	<b>TYPE</b>	<b>HEAD AF</b>	<b>WT./M</b>	<b>PRICE PER 1000</b>			
						<b>PLAIN</b>	<b>PAINTED</b>		
	<p>#10      1"      WOODGRIP      5/16"</p> <p>#10      1-1/2"      WOODGRIP      5/16"</p> <p>#10      2"      WOODGRIP      5/16"</p> <p>Note: Fasteners sold in quantities of 250 only.</p>	9.5#	11.5#	14.0#	171.85	186.15	256.25	185.35	199.65
<p><b>STAINLESS STEEL POP RIVETS</b></p>  <p>Note: Fasteners sold in quantities of 250 only.</p>	<b>SIZE</b>	<b>GRIP RANGE</b>		<b>WT./M.</b>		<b>PRICE PER 1000</b>			
						<b>PLAIN</b>	<b>PAINTED</b>		
	<p>1/8" Diameter      .126" - .187"</p> <p>2.8#</p> <p>Note: Fasteners sold in quantities of 250 only.</p>	96.30	103.20						

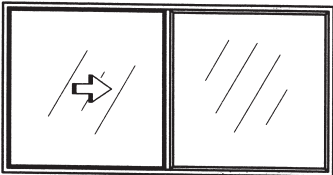
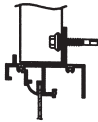

## ACCESSORIES

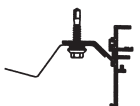
	DESCRIPTION	PRICE PER UNIT																																																										
<p style="text-align: center;"><b>PERSONNEL DOOR UNITS</b></p>  <p style="text-align: center;">* SBS standard door includes integral weather strip.</p>	<table border="1" style="width: 100%; border-collapse: collapse;"> <thead> <tr style="background-color: #cccccc;"> <th>DOOR SIZE</th> <th>STYLE</th> <th>WT./UNIT</th> <th>WHITE FINISH</th> </tr> </thead> <tbody> <tr> <td>3070 (single leaf)</td> <td>"M"</td> <td>166#</td> <td>495.00</td> </tr> <tr> <td>3070 (single leaf)</td> <td>"G" or "NL"</td> <td>161#</td> <td>552.00</td> </tr> <tr> <td>4070 (single leaf)</td> <td>"M"</td> <td>190#</td> <td>604.55</td> </tr> <tr> <td>4070 (single leaf)</td> <td>"G" or "NL"</td> <td>185#</td> <td>673.40</td> </tr> <tr> <td>6070 (double leaf)</td> <td>"M"</td> <td>265#</td> <td>900.90</td> </tr> <tr> <td>6070 (double leaf)</td> <td>"G" or "NL"</td> <td>255#</td> <td>1014.90</td> </tr> </tbody> </table> <p>Single leaf door unit includes: leaf, frame with integral weather strip, assembly bolts, plain bearing hinges and threshold.</p> <p>Double leaf door unit includes: two surface bolts, handed astragal and lock hole filler plate in addition to the items listed for the single leaf unit. Glass and glazing is not included on "G" or "NL".</p> <p>All white door leaves are embossed.</p> <p>ADA regulations require lever lockset for public access buildings.</p> <p style="text-align: center;">* SBS standard door includes integral weather strip.</p>	DOOR SIZE	STYLE	WT./UNIT	WHITE FINISH	3070 (single leaf)	"M"	166#	495.00	3070 (single leaf)	"G" or "NL"	161#	552.00	4070 (single leaf)	"M"	190#	604.55	4070 (single leaf)	"G" or "NL"	185#	673.40	6070 (double leaf)	"M"	265#	900.90	6070 (double leaf)	"G" or "NL"	255#	1014.90																															
DOOR SIZE	STYLE	WT./UNIT	WHITE FINISH																																																									
3070 (single leaf)	"M"	166#	495.00																																																									
3070 (single leaf)	"G" or "NL"	161#	552.00																																																									
4070 (single leaf)	"M"	190#	604.55																																																									
4070 (single leaf)	"G" or "NL"	185#	673.40																																																									
6070 (double leaf)	"M"	265#	900.90																																																									
6070 (double leaf)	"G" or "NL"	255#	1014.90																																																									
<p style="text-align: center;"><b>DOOR COMPONENTS</b></p>  <p style="text-align: center;">REMOVABLE MULLION APPLICATION</p>	<table border="1" style="width: 100%; border-collapse: collapse;"> <thead> <tr style="background-color: #cccccc;"> <th>DESCRIPTION</th> <th>PRICE PER UNIT</th> </tr> <tr style="background-color: #cccccc;"> <th></th> <th>WHITE FINISH</th> </tr> </thead> <tbody> <tr> <td>3070 "M" Door Leaf only . . . . .</td> <td>237.50</td> </tr> <tr> <td>3070 "G" or "NL" Door Leaf only . . . . .</td> <td>294.50</td> </tr> <tr> <td>4070 "M" Door Leaf only . . . . .</td> <td>323.00</td> </tr> <tr> <td>4070 "G" or "NL" Door Leaf only . . . . .</td> <td>391.90</td> </tr> <tr> <td>3070 Frame, 8 1/4" Depth (includes assembly bolts) . . . . .</td> <td>257.50</td> </tr> <tr> <td>4070 Frame, 8 1/4" Depth (includes assembly bolts) . . . . .</td> <td>281.55</td> </tr> <tr> <td>6070 Frame, 8 1/4" Depth (includes assembly bolts) . . . . .</td> <td>425.90</td> </tr> <tr> <td>Handed Astragal (specify leaf attaching to) . . . . .</td> <td>43.75</td> </tr> <tr> <td>Lock Hole Filler Plate (used on inactive leaf) . . . . .</td> <td>7.50</td> </tr> <tr> <td>Aluminum Threshold (ADA) 1/2" high. (includes anchors, screws, and sweep)</td> <td></td> </tr> <tr> <td>3'-0" . . . . .</td> <td>26.25</td> </tr> <tr> <td>4'-0" . . . . .</td> <td>36.15</td> </tr> <tr> <td>6'-0" . . . . .</td> <td>52.50</td> </tr> <tr> <td>Surface Bolt, US26D (2 required per leaf) . . . . .</td> <td>66.75</td> </tr> <tr> <td>Full Mortise Hinges, 4 1/2" x 4 1/2" Steel, US26D, Non-Removable Pins, (3/Box)</td> <td></td> </tr> <tr> <td>Plain Bearing . . . . .</td> <td>34.05</td> </tr> <tr> <td>Ball Bearing . . . . .</td> <td>51.40</td> </tr> <tr> <td>Thru-Mounted, Hydraulic, Size IV Door Closer . . . . .</td> <td>136.25</td> </tr> <tr> <td>Standard Duty Cylindrical Lockset Knob, US32D . . . . .</td> <td>81.25</td> </tr> <tr> <td>Heavy Duty Cylindrical Lockset Knob, US26D . . . . .</td> <td>215.00</td> </tr> <tr> <td>Lever Type Cylindrical Lockset, US26D (ADA) . . . . .</td> <td>136.25</td> </tr> <tr> <td>Mortise Lever Lockset, (function 86A), US26D (requires a specially prepared leaf) (ADA) . . . . .</td> <td>337.50</td> </tr> <tr> <td>Keyed Alike Charge, per Lock . . . . .</td> <td>15.00</td> </tr> <tr> <td>Surface Mounted Reversible Panic Device, US26D (has keyed lever for exterior entry) (ADA) . . . . .</td> <td>442.50</td> </tr> <tr> <td>Removable Mullion (Must be used on double leaf door when using above panic device), gray only . . . . .</td> <td>375.00</td> </tr> <tr> <td>Double Cylinder Dead Bolt, US32D, (lock only, door prep charges not included) . . . . .</td> <td>75.00</td> </tr> <tr> <td>Dead Bolt Preparation Charges for Door Leaf and Frame (this hands leaf and frame) . . . . .</td> <td>113.00</td> </tr> </tbody> </table>	DESCRIPTION	PRICE PER UNIT		WHITE FINISH	3070 "M" Door Leaf only . . . . .	237.50	3070 "G" or "NL" Door Leaf only . . . . .	294.50	4070 "M" Door Leaf only . . . . .	323.00	4070 "G" or "NL" Door Leaf only . . . . .	391.90	3070 Frame, 8 1/4" Depth (includes assembly bolts) . . . . .	257.50	4070 Frame, 8 1/4" Depth (includes assembly bolts) . . . . .	281.55	6070 Frame, 8 1/4" Depth (includes assembly bolts) . . . . .	425.90	Handed Astragal (specify leaf attaching to) . . . . .	43.75	Lock Hole Filler Plate (used on inactive leaf) . . . . .	7.50	Aluminum Threshold (ADA) 1/2" high. (includes anchors, screws, and sweep)		3'-0" . . . . .	26.25	4'-0" . . . . .	36.15	6'-0" . . . . .	52.50	Surface Bolt, US26D (2 required per leaf) . . . . .	66.75	Full Mortise Hinges, 4 1/2" x 4 1/2" Steel, US26D, Non-Removable Pins, (3/Box)		Plain Bearing . . . . .	34.05	Ball Bearing . . . . .	51.40	Thru-Mounted, Hydraulic, Size IV Door Closer . . . . .	136.25	Standard Duty Cylindrical Lockset Knob, US32D . . . . .	81.25	Heavy Duty Cylindrical Lockset Knob, US26D . . . . .	215.00	Lever Type Cylindrical Lockset, US26D (ADA) . . . . .	136.25	Mortise Lever Lockset, (function 86A), US26D (requires a specially prepared leaf) (ADA) . . . . .	337.50	Keyed Alike Charge, per Lock . . . . .	15.00	Surface Mounted Reversible Panic Device, US26D (has keyed lever for exterior entry) (ADA) . . . . .	442.50	Removable Mullion (Must be used on double leaf door when using above panic device), gray only . . . . .	375.00	Double Cylinder Dead Bolt, US32D, (lock only, door prep charges not included) . . . . .	75.00	Dead Bolt Preparation Charges for Door Leaf and Frame (this hands leaf and frame) . . . . .	113.00	
DESCRIPTION	PRICE PER UNIT																																																											
	WHITE FINISH																																																											
3070 "M" Door Leaf only . . . . .	237.50																																																											
3070 "G" or "NL" Door Leaf only . . . . .	294.50																																																											
4070 "M" Door Leaf only . . . . .	323.00																																																											
4070 "G" or "NL" Door Leaf only . . . . .	391.90																																																											
3070 Frame, 8 1/4" Depth (includes assembly bolts) . . . . .	257.50																																																											
4070 Frame, 8 1/4" Depth (includes assembly bolts) . . . . .	281.55																																																											
6070 Frame, 8 1/4" Depth (includes assembly bolts) . . . . .	425.90																																																											
Handed Astragal (specify leaf attaching to) . . . . .	43.75																																																											
Lock Hole Filler Plate (used on inactive leaf) . . . . .	7.50																																																											
Aluminum Threshold (ADA) 1/2" high. (includes anchors, screws, and sweep)																																																												
3'-0" . . . . .	26.25																																																											
4'-0" . . . . .	36.15																																																											
6'-0" . . . . .	52.50																																																											
Surface Bolt, US26D (2 required per leaf) . . . . .	66.75																																																											
Full Mortise Hinges, 4 1/2" x 4 1/2" Steel, US26D, Non-Removable Pins, (3/Box)																																																												
Plain Bearing . . . . .	34.05																																																											
Ball Bearing . . . . .	51.40																																																											
Thru-Mounted, Hydraulic, Size IV Door Closer . . . . .	136.25																																																											
Standard Duty Cylindrical Lockset Knob, US32D . . . . .	81.25																																																											
Heavy Duty Cylindrical Lockset Knob, US26D . . . . .	215.00																																																											
Lever Type Cylindrical Lockset, US26D (ADA) . . . . .	136.25																																																											
Mortise Lever Lockset, (function 86A), US26D (requires a specially prepared leaf) (ADA) . . . . .	337.50																																																											
Keyed Alike Charge, per Lock . . . . .	15.00																																																											
Surface Mounted Reversible Panic Device, US26D (has keyed lever for exterior entry) (ADA) . . . . .	442.50																																																											
Removable Mullion (Must be used on double leaf door when using above panic device), gray only . . . . .	375.00																																																											
Double Cylinder Dead Bolt, US32D, (lock only, door prep charges not included) . . . . .	75.00																																																											
Dead Bolt Preparation Charges for Door Leaf and Frame (this hands leaf and frame) . . . . .	113.00																																																											

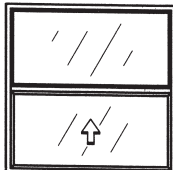
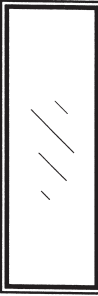
## ACCESSORIES

	DESCRIPTION	PRICE EACH																								
<p><b>HORIZONTAL SLIDE WINDOWS</b></p>  <div style="display: flex; justify-content: space-around; margin-top: 10px;">   </div> <div style="display: flex; justify-content: space-around; margin-top: 10px;"> <p>Head</p> <p>Sill</p> </div> <div style="display: flex; justify-content: space-around; margin-top: 10px;">   </div> <div style="display: flex; justify-content: space-around; margin-top: 10px;"> <p>PBR Panel Fin</p> <p>PBU Panel Fin</p> </div> <div style="display: flex; justify-content: space-around; margin-top: 10px;">   </div> <div style="display: flex; justify-content: space-around; margin-top: 10px;"> <p>PBA Panel Fin</p> <p>Straight Panel Fin</p> </div>	<table style="width: 100%; border-collapse: collapse;"> <thead> <tr> <th style="width: 30%;">SIZE</th> <th style="width: 30%;">WT./EA.</th> <th style="width: 40%;">PRICE EACH</th> </tr> </thead> <tbody> <tr> <td>3030 w/ half-screen</td> <td style="text-align: right;">24.0#</td> <td style="text-align: right;">195.00</td> </tr> <tr> <td>4030 w/ half-screen</td> <td style="text-align: right;">31.8#</td> <td style="text-align: right;">220.00</td> </tr> <tr> <td>6030 w/ half-screen</td> <td style="text-align: right;">43.8#</td> <td style="text-align: right;">265.00</td> </tr> <tr> <td>6040 w/ half-screen</td> <td style="text-align: right;">57.8#</td> <td style="text-align: right;">362.50</td> </tr> </tbody> </table> <p style="font-size: small; margin-top: 10px;">Specify PBR Panel, PBU Panel, A Panel, or Straight Fins. All windows have field installed fins to fit the specified panel. Width of window is indicated by the first two digits in the description and is measured center-to-center of the fins. Windows are self-framing and require no additional flashing or trim. Glass is clear DSB grade. LTL crating charge is \$50 per order.</p>	SIZE	WT./EA.	PRICE EACH	3030 w/ half-screen	24.0#	195.00	4030 w/ half-screen	31.8#	220.00	6030 w/ half-screen	43.8#	265.00	6040 w/ half-screen	57.8#	362.50	<table style="width: 100%; border-collapse: collapse;"> <thead> <tr> <th style="width: 30%;"></th> <th style="width: 35%;">DESCRIPTION</th> <th style="width: 35%;">PRICE EACH</th> </tr> </thead> <tbody> <tr> <td></td> <td style="text-align: center;"><b>MILL FINISH</b></td> <td></td> </tr> <tr> <td></td> <td style="text-align: center;"><b>ALUMINUM FRAME/FINS</b></td> <td></td> </tr> </tbody> </table>		DESCRIPTION	PRICE EACH		<b>MILL FINISH</b>			<b>ALUMINUM FRAME/FINS</b>	
	SIZE	WT./EA.	PRICE EACH																							
	3030 w/ half-screen	24.0#	195.00																							
	4030 w/ half-screen	31.8#	220.00																							
	6030 w/ half-screen	43.8#	265.00																							
6040 w/ half-screen	57.8#	362.50																								
	DESCRIPTION	PRICE EACH																								
	<b>MILL FINISH</b>																									
	<b>ALUMINUM FRAME/FINS</b>																									
<p><b>VERTICAL SLIDE WINDOWS</b></p> 	<table style="width: 100%; border-collapse: collapse;"> <thead> <tr> <th style="width: 30%;">SIZE</th> <th style="width: 30%;">WT./EA.</th> <th style="width: 40%;">PRICE EACH</th> </tr> </thead> <tbody> <tr> <td>3030 w/ half-screen</td> <td style="text-align: right;">30.0#</td> <td style="text-align: right;">292.50</td> </tr> <tr> <td>3040 w/ half-screen</td> <td style="text-align: right;">34.0#</td> <td style="text-align: right;">337.50</td> </tr> <tr> <td>3050 w/ half-screen</td> <td style="text-align: right;">38.0#</td> <td style="text-align: right;">385.00</td> </tr> </tbody> </table> <p style="font-size: small; margin-top: 10px;">Specify PBR Panel, PBU Panel, A Panel, or Straight Fins. All windows have field installed fins to fit the specified panel. Width of window is indicated by the first two digits in the description and is measured center-to-center of the fins. Windows are self-framing and require no additional flashing or trim. Glass is clear DSB grade. LTL crating charge is \$50 per order.</p>	SIZE	WT./EA.	PRICE EACH	3030 w/ half-screen	30.0#	292.50	3040 w/ half-screen	34.0#	337.50	3050 w/ half-screen	38.0#	385.00	<table style="width: 100%; border-collapse: collapse;"> <thead> <tr> <th style="width: 30%;"></th> <th style="width: 35%;">DESCRIPTION</th> <th style="width: 35%;">PRICE EACH</th> </tr> </thead> <tbody> <tr> <td></td> <td style="text-align: center;"><b>MILL FINISH</b></td> <td></td> </tr> <tr> <td></td> <td style="text-align: center;"><b>ALUMINUM FRAMES/FINS</b></td> <td></td> </tr> </tbody> </table>		DESCRIPTION	PRICE EACH		<b>MILL FINISH</b>			<b>ALUMINUM FRAMES/FINS</b>				
	SIZE	WT./EA.	PRICE EACH																							
	3030 w/ half-screen	30.0#	292.50																							
3040 w/ half-screen	34.0#	337.50																								
3050 w/ half-screen	38.0#	385.00																								
	DESCRIPTION	PRICE EACH																								
	<b>MILL FINISH</b>																									
	<b>ALUMINUM FRAMES/FINS</b>																									
<p><b>FIXED GLASS SLIMLINE WINDOWS</b></p> 	<table style="width: 100%; border-collapse: collapse;"> <thead> <tr> <th style="width: 30%;">SIZE</th> <th style="width: 30%;">WT./EA.</th> <th style="width: 40%;">PRICE EACH</th> </tr> </thead> <tbody> <tr> <td>1070</td> <td style="text-align: right;">40.0#</td> <td style="text-align: right;">370.00</td> </tr> <tr> <td>2060</td> <td style="text-align: right;">50.0#</td> <td style="text-align: right;">402.50</td> </tr> <tr> <td>2070</td> <td style="text-align: right;">52.0#</td> <td style="text-align: right;">415.00</td> </tr> </tbody> </table> <p style="font-size: small; margin-top: 10px;">Specify PBR Panel, PBU Panel, A Panel, or Straight Fins. All windows have field installed fins to fit the specified panel. Width of window is indicated by the first two digits in the description and is measured center-to-center of the fins. Windows are self-framing and require no additional flashing or trim. Glass is 1/8" Gray Tinted Tempered. LTL crating charge is \$50 per order.</p>	SIZE	WT./EA.	PRICE EACH	1070	40.0#	370.00	2060	50.0#	402.50	2070	52.0#	415.00	<table style="width: 100%; border-collapse: collapse;"> <thead> <tr> <th style="width: 30%;"></th> <th style="width: 35%;">DESCRIPTION</th> <th style="width: 35%;">PRICE EACH</th> </tr> </thead> <tbody> <tr> <td></td> <td style="text-align: center;"><b>BRONZE PAINTED</b></td> <td></td> </tr> <tr> <td></td> <td style="text-align: center;"><b>ALUMINUM FRAMES/FINS</b></td> <td></td> </tr> </tbody> </table>		DESCRIPTION	PRICE EACH		<b>BRONZE PAINTED</b>			<b>ALUMINUM FRAMES/FINS</b>				
	SIZE	WT./EA.	PRICE EACH																							
	1070	40.0#	370.00																							
	2060	50.0#	402.50																							
2070	52.0#	415.00																								
	DESCRIPTION	PRICE EACH																								
	<b>BRONZE PAINTED</b>																									
	<b>ALUMINUM FRAMES/FINS</b>																									

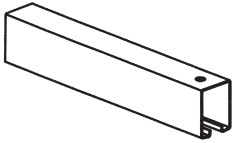
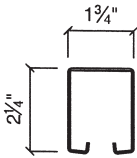
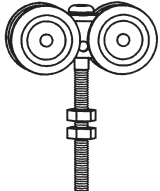
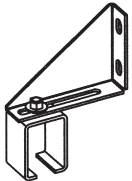
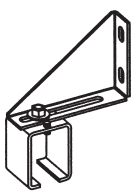
## ACCESSORIES

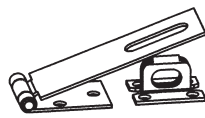
 <p style="text-align: center;">Track Cross Section</p>  <p style="font-size: small;">All track is 16 ga. Galvanized.</p>	DESCRIPTION		PRICE EACH
	LENGTH	WT./EA.	
	Door Track x 8'-0	14.2#	40.50
	Door Track x 10'-0	16.5#	60.00
	Door Track x 12'-0	20.8#	73.20
	Door Track x 14'-0	23.6#	80.25
	Door Track x 16'-0	28.3#	96.25
	Door Track x 18'-0	31.9#	109.75
	Door Track x 20'-0	33.0#	120.00
	Maximum door weight should be 400 lbs.		
<p style="text-align: center;">NATIONAL SLIDING DOOR HARDWARE</p>      <p style="font-size: small;">All hardware is zinc-plated.</p>	DESCRIPTION		PRICE EACH
	ITEM	WT./EA.	
	2 1/8" diameter Trolley Truck w/ 5 1/2" bolt. (max. door weight 400 lbs.)	1.2#	21.55
	Track Hanger Bracket. (use every 2' of track)	1.4#	16.90
	Track Hanger/Splice Bracket (has set screw)	1.5#	22.25
	#7 Extra Heavy Duty Door Pull.	.9#	9.40
	4 1/2" Hasp and Staple set.	.3#	5.25