

TABLE OF CONTENTS

SSR SYSTEMS PRICING

I. PANELS	
1. TS-324.....	SSR-2-3
2. VS-216.....	SSR-4-5
II. STRUCTURAL	
1. LIGHT GAUGE FRAMING	SSR-6
III. ACCESSORIES	
1. CLIPS	SSR-7
2. EAVE PLATES	SSR-8
3. RAKE SUPPORT ANGLES	SSR-8
4. BACK-UP PLATES	SSR-9
5. OUTSIDE CLOSURES	SSR-9
6. INSIDE CLOSURES	SSR-9
7. ENDLAP CINCH STRAP.....	SSR-9
8. GUTTER STRAP	SSR-10
9. TAPE SEALER	SSR-10
10. TUBE CAULKING	SSR-10
11. HAND SEAMERS	SSR-10
12. TOUCH-UP PAINT	SSR-10
13. CONTINUOUS VENTS	SSR-11
14. VENT HARDWARE	SSR-11
15. LIGHT TRANSMITTING PANELS	SSR-11
16. FASTENERS	SSR-12-13
17. FLAT SHEETS	SSR-15
IV. TRIM.....	SSR-16-25
V. SEAM TYPES.....	SSR-26

TS-324 PANEL PROFILE

TS-324 Panel

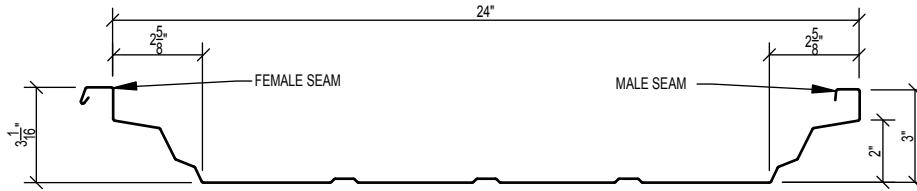

PANEL PRICING								
FINISH	GAUGE	PSI YIELD STRENGTH	LIMITED FINISH WARRANTY	GALVALUME® BASE METAL COATING	WEIGHT PER SQUARE	PRICE PER SQUARE / PURCHASE QUANTITY		
						0 - 50 SQUARES	> 50 - 100 SQUARES	100+ SQUARES
Clear Acrylic Coating	24	50,000	25 Years	AZ55	121#	\$282.00	\$270.00	\$265.00
SMP Solar White	24	50,000	40 Years	AZ50	121#	\$384.00	\$369.00	\$361.00

GALVALUME® is a registered trademark of BIEC International Inc.

PANEL PRICING:

1. All panel pricing is based on net coverage.
2. For short lengths add \$4.00 per panel for panels 3" – 2'-9" or \$2.50 per panel for panels 2'-10" – 5'-11" (Panels less than 6'-0" cannot be prepunched and notched).
3. The TS-324 panels must be mechanically seamed to complete installation. Seaming machines for this panel are available for rental at www.schulteseamers.com and are financial responsibility of the renting party.
4. TS-324 panel is manufactured in Hockley, TX and Hueytown, AL.

PACKAGING COST:

1. Maximum 18 sheets per bundle.
2. Standard packaging: Block and Band — 8'-0" O.C.with strippable film (on color panels only) on the male and female rib
3. Export or LTD packaging Please inquire:

NOTES:

1. All panels are factory notched and pre-punched both ends.
2. All panels have factory applied sealant.
3. Panels over 52'-0" or under 6'-0" Please inquire.
4. Yield strength is 50,000 PSI on 24 gauge panels.
5. Oil-Canning is not a cause for rejection.

VS-216 PANEL PROFILE

VS-216 Panel

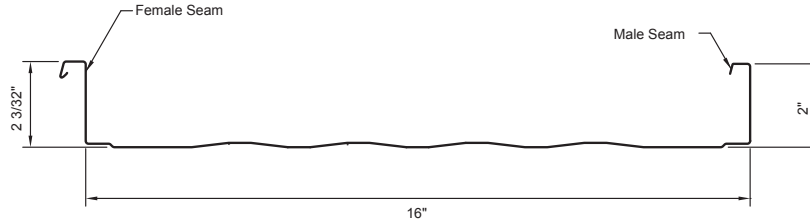

PANEL PRICING

FINISH	GAUGE	PSI YIELD STRENGTH	LIMITED FINISH WARRANTY	GALVALUME® BASE METAL COATING	WEIGHT PER SQUARE	PRICE PER SQUARE / PURCHASE QUANTITY		
						0 - 50 SQUARES	> 50 - 100 SQUARES	100+ SQUARES
Clear Acrylic Coating	24	50,000	25 Years	AZ55	132#	\$341.00	\$327.00	\$320.00
SMP Solar White	24	50,000	40 Years	AZ50	132#	\$374.00	\$358.00	\$350.00
Kynar 500® Standard Colors	24	50,000	35 Years	AZ50	132#	\$401.00	\$385.00	\$377.00

See current SBS Color Chart for available Standard Colors.

Kynar 500® is a registered trademark of ELF Atochem • GALVALUME® is a registered trademark of BIEC International Inc.

PANEL PRICING:

1. All panel pricing is based on net coverage.
2. For short lengths add \$4.00 per panel for panels 3' – 2'-9" or \$2.50 per panel for panels 2'-10" – 5'-11" (Panels less than 6'-0" cannot be prepunched and notched).
3. The VS-216 panels must be mechanically seamed to complete installation. Seaming machines for this panel are available for rental at www.schulteseamers.com and are financial responsibility of the renting party.
4. VS-216 panel is manufactured in Hockley, TX and Hueytown, AL.

PACKAGING COST:

1. Maximum 18 sheets per bundle.
2. Standard packaging: Block and Band — 8'-0" O.C. with strippable film (on color panels only) on the male and female rib
3. Export or LTD packaging Please inquire:

NOTES:

1. All panels are factory notched and pre-punched both ends.
2. All panels have factory applied sealant.
3. Panels over 52'-0" or under 6'-0" Please inquire.
4. Yield strength is 50,000 PSI on 24 gauge panels.
5. Oil-Canning is not a cause for rejection.

PANEL INFORMATION

HOW TO CALCULATE SQUARES OF PANELS:

One square = 100 square feet of panels. Both TS-324 and VS-216 squares are calculated based on actual panel coverage to weather.

For TS-324 panels, the coverage is 2'-0". Simply add all of the LFT of TS-324 panels required, multiply by 2 - then divide by 100.

For example, if there are 40 panels @ 42'-0" long, there would be a total panel LFT of 1,680. Multiplying that by 2 = 3,360 square feet of coverage. Dividing that by 100 = 33.6 squares.

For VS-216 panels, the coverage is 1'-4" or 1.33'. Simply add all of the LFT of VS-216 panels required, multiply by 1.33 - then divide by 100.

For example, if there are 40 panels @ 42'-0" long, there would be a total panel LFT of 1,680. Multiplying that by 1.33 = 2,234.4 square feet of coverage. Dividing that by 100 = 22.344 squares.

PANEL PRODUCT INFORMATION:

1. Clear Acrylic-Coated GALVALUME®:
 - a. Clear Acrylic-Coated GALVALUME® incorporates a thin, non-warranted clear acrylic film intended to increase its resistance to fingerprinting and handling marks during the erection process as well as eliminating the need for using oil in the forming process. This clear acrylic film could discolor during the weathering process. This is not a cause for rejection.
 - b. Clear Acrylic-Coated GALVALUME®'s metallic coating spangle appearance and shade could vary from coil-to-coil and may be noticeable during or after erection or during the weathering process. This is not a cause for rejection.
 - c. Neither of the aforementioned aesthetic issues diminish the structural integrity nor affect the limited panel warranty. If a consistent appearance is a priority, SBS recommends that pre-painted panels be used in lieu of Clear Acrylic-Coated GALVALUME®
2. Painted Finish Panels:
 - a. The top coat paint thickness is a nominal 1.0 mils (+/- 0.2 mils) inclusive of the primer.
 - b. The off-white backer coat paint thickness is a nominal 0.5 mils (+/- 0.1 mils) inclusive of the primer.
3. All panels have a length tolerance of plus or minus 1/4" from ordered length.
4. Maximum panel length is 52'-0". Longer lengths are possible but may require a higher cost, permitted delivery. Please inquire.

PANEL PERFORMANCE WARNINGS

The building panels are manufactured to the highest quality standards, offering long-term durability and performance. To assure optimum panel performance, special precautions must be taken while the panels are in a packaged state. Please take notice of the followings WARNINGS to insure that your panels are properly protected prior to installation and installed properly. Failure to follow these recommendations could void any panel warranty.

A. JOBSITE STORAGE

1. All building panels are extremely vulnerable to finish deterioration from moisture when in the nested, packaged condition. Long term storage of these panels (over 30 days) in the nested, packaged condition can be detrimental and may void the panel finish warranty. Erect panels immediately upon receipt for best results.
2. Moisture can form between dry panels from temperature changes alone. This can happen even when kept undercover, out of the elements, and especially in winter. It is very important to install all panels as soon as possible.
3. Job site storage is the responsibility of the buyer and should always include tarping and the elevation of one end of every panel package to aid in the draining of any moisture that may accumulate between panels. Panels should always be stored above rising water levels.
4. Panels with evidence of water stain, paint blistering or other defects attributed to improper or long term field storage will not be eligible for claim.

B. INSTALLATION

1. All metal shavings or iron filings created during the erection process by drilling holes, cutting, or sawing must be swept off of the roof and wall panels daily. Failure to do so may cause permanent rust stains on the painted surface. Claims will not be accepted for this problem.
2. Cutting of panels or trim with circular saws is strongly discouraged. The fine metal particles created are hot and will embed themselves into any painted surface they contact. Removal of all of these particles is nearly impossible and will cause rust spots on the painted surfaces. This problem occurs most when cutting endwall panels to slope or cutting around wall openings. Claims will not be accepted for this problem.
3. Never cut the blanket insulation off even with the edge of the panels as this will cause "wicking" of moisture and will promote panel rust. Always fold back the insulation, with facing outward, at least 1" away from the panel edge.
4. All panels should be installed in accordance with the SBS Installation & Seaming Guides, available on www.sbsp.com, for the specific TS-324 or VS-216 panel, as applicable.

PANEL INFORMATION

PANEL INSTALLATION SAFETY WARNINGS

1. These panels should be installed by a qualified professional that is knowledgeable with the proper installation of metal building panels and the safety precautions required.
2. Never install panels without wearing a tied-off safety harness and/or using a safety net as required by OSHA.
3. Painted panels are coated with a wax to protect the painted surface during shipment. All panels should be viewed as extremely slippery, even if dry.
4. Never install or walk on wet building panels. Panels become extremely slippery when wet and could cause slippage or injury.
5. Take extreme care when walking on panels early in the morning as morning dew could be present and cause panels to be extremely slippery.
6. Never install panels in inclement weather (i.e. ice, snow, rain, lightning, etc.) as slippage or injury could occur.
7. All sloped roofs are dangerous. Be extremely careful when working on any sloped roof to avoid slipping or loss of balance.
8. Never install panels on windy days. Installers may be subject to injury if wind gusts cause them to lose their balance while carrying panels.
9. Be extremely careful installing panels (or any other steel or metal items) near electrical lines as these panels or items will conduct electricity and could cause electrocution.
10. Never walk on the top panel of an unsecured package of panels. The top panel will slide easily and may cause a fall and/or injury.
11. Never leave a bundle of panels unsecured on the sloped roof of a structure. The panels could slide off the roof like a "deck-of-cards" causing injury to those on the ground.
12. Always handle panels with care as all panel edges are sharp and can easily cause injury. Whenever possible, use gloves when handling.

TECHNICAL INFORMATION:

For product application, design details and other product information, visit our web site at SBSLP.com and click on the Guides and Product Brochures link in the Components Tab.

ACCESSORIES

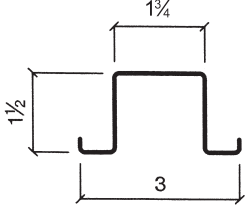
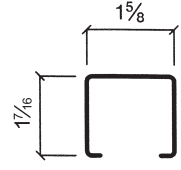
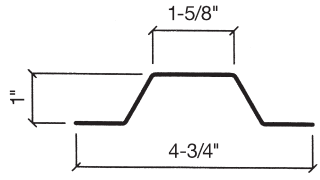
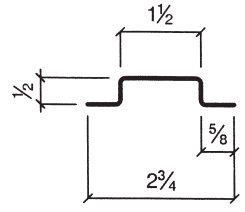
	PART NO.	LENGTH	GAUGE	FINISH	WT./EA.	PRICE PER EACH
HAT SECTION 						
	HS-106	20'-0"	16	Red-Oxide	25.00#	Inquire
	HS-106	20'-0"	16	Galvanized	26.90#	Inquire
CHANNEL SECTION 	PART NO.	LENGTH	GAUGE	FINISH	WT./EA.	PRICE PER EACH
	CS-101	20'-0"	18	Galvanized	15.60#	Inquire
1" SUB-GIRT 	PART NO.	LENGTH	GAUGE	FINISH	WT./EA.	PRICE PER EACH
	SG-101	20'-0"	18	Galvanized	18.60#	Inquire
1/2" SUB-GIRT 	PART NO.	LENGTH	GAUGE	FINISH	WT./EA.	PRICE PER EACH
	SG-102	20'-0"	18	Galvanized	12.32#	Inquire

ACCESSORIES

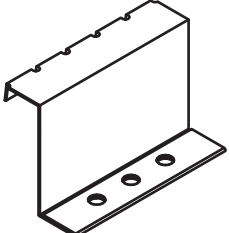
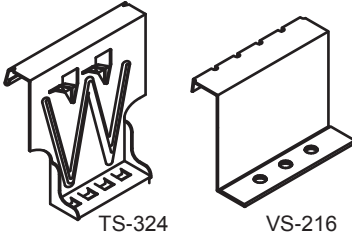
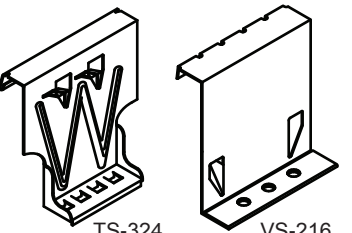
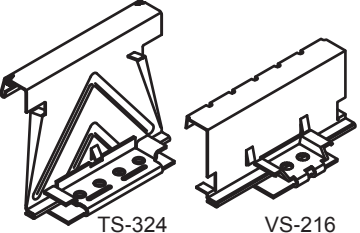
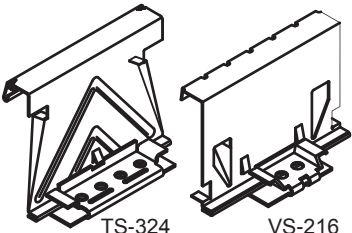
	PART NO.	SSR SYSTEM	HEIGHT	WT./EA.	PRICE PER EACH
<p>UTILITY CLIP</p> 	FC-10200	VS-216	2"	.12#	\$1.25
	<p>LOW FIXED CLIP (FOR 3/8" STAND-OFF)</p>  <p>TS-324 VS-216</p>	FC-462	TS-324	3 ³ / ₈ "	.20#
FC-10203		VS-216	2 ³ / ₈ "	.13#	\$1.15
<p>HIGH FIXED CLIP (FOR 1³/₈" STAND-OFF)</p>  <p>TS-324 VS-216</p>	FC-463	TS-324	4 ³ / ₈ "	.25#	\$2.25
	FC-10213	VS-216	3 ³ / ₈ "	.18#	\$1.30
<p>LOW FLOATING CLIP (FOR 3/8" STAND-OFF)</p>  <p>TS-324 VS-216</p>	MPS-602S	TS-324	3 ³ / ₈ "	.40#	\$3.50
	MC-1203	VS-216	2 ³ / ₈ "	.23#	\$2.25
<p>HIGH FLOATING CLIP (FOR 1³/₈" STAND-OFF)</p>  <p>TS-324 VS-216</p>	MPS-603S	TS-324	4 ³ / ₈ "	.44#	\$4.00
	MC-1213	VS-216	3 ³ / ₈ "	.25#	\$2.50



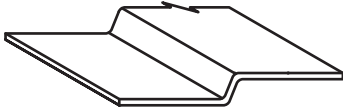
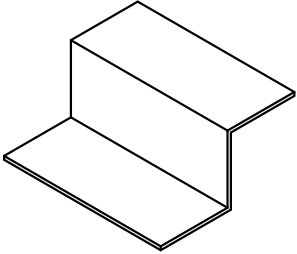
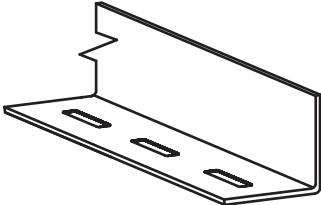
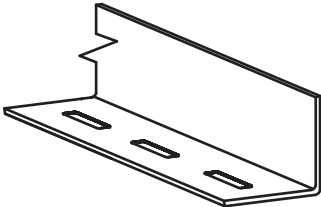

ACCESSORIES

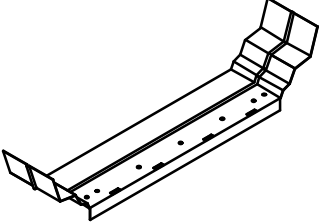
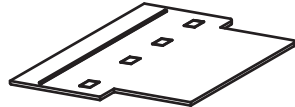
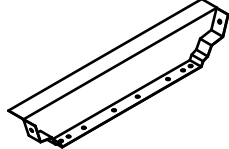
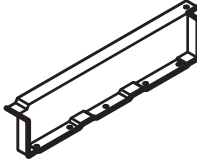
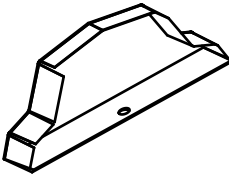
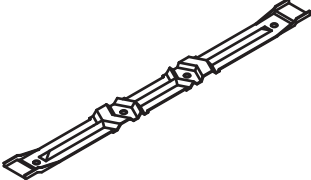
	PART NO.	SSR SYS.	GAUGE	LENGTH	FINISH	WT./EA.	PRICE PER EACH	
<p style="text-align: center;">EAVE PLATE (FOR 3/8" STAND-OFF)</p> 	EP038		16	10'-0"	Galvanized	8.50#	\$68.85	
	<p>Use with TS324 and VS216</p> <p>Use with Low Clips</p>							
<p style="text-align: center;">EAVE PLATE (FOR 1 3/8" STAND-OFF)</p> 	EP138		16	10'-0"	Galvanized	8.50#	\$68.85	
	<p>Use with TS324 and VS216</p> <p>Use with High Clips</p>							
<p style="text-align: center;">RAKE SUPPORT ANGLE (FOR 3/8" STAND-OFF)</p> 	PART NO.	SSR SYS.	SIZE	GAUGE	LENGTH	FINISH	WT./EA.	PRICE PER EACH
	RSA-338	TS324	3 3/8 X 2 1/2	14	20'-0"	R/O	28.71#	\$129.60
	RSA2-38	VS216	2 3/8 X 3 1/2	14	20'-0"	R/O	28.71#	\$129.60
<p>Use with Low Clips</p>								
<p style="text-align: center;">RAKE SUPPORT ANGLE (FOR 1 3/8" STAND-OFF)</p> 	PART NO.	SSR SYS.	SIZE	GAUGE	LENGTH	FINISH	WT./EA.	PRICE PER EACH
	RSA-438	TS324	4 3/8 X 1 1/2	14	20'-0"	R/O	28.71#	\$129.60
	RSA-338	VS216	3 3/8 X 2 1/2	14	20'-0"	R/O	28.71#	\$129.60
<p>Use with High Clips</p>								

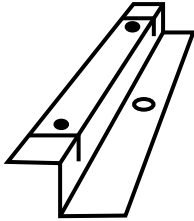
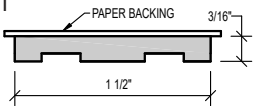

ACCESSORIES

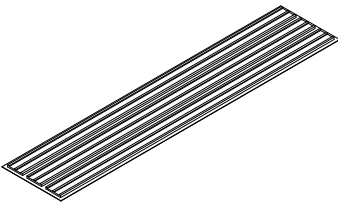
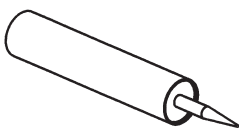
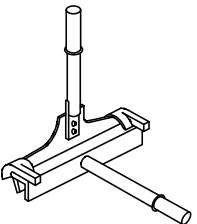
ENDLAP BACK-UP PLATE (FOR 24" PANEL) 	PART NO. SSR SYSTEM WIDTH GAUGE FINISH WT./EA.	PRICE PER EACH
	BUP-324 TS-324 24" 16 Galvanized 2.41#	\$4.50
ENDLAP BACK-UP PLATE (FOR 16" PANEL) 	PART NO. SSR SYSTEM WIDTH GAUGE FINISH WT./EA.	PRICE PER EACH
	BUP-216 VS-216 15½" 16 Galvanized 1.90#	\$4.50
OUTSIDE CLOSURE (FOR 24" PANEL) 	PART NO. SSR SYSTEM WIDTH GAUGE FINISH WT./EA.	PRICE PER EACH
	OSC-324A TS-324 24" 24 Galvalume® 1.09#	\$3.50
	OSC-324B TS-324 24" 24 Painted 1.09#	\$4.50
OUTSIDE CLOSURE (FOR 16" PANEL) 	PART NO. SSR SYSTEM WIDTH GAUGE FINISH WT./EA.	PRICE PER EACH
	OSC-216A VS-216 16" 24 Galvalume® .41#	\$3.50
	OSC-216B VS-216 16" 24 Painted .41#	\$4.50
CORRUGATION CLOSURE 	PART NO. SSR SYSTEM WIDTH GAUGE FINISH WT./EA.	PRICE PER EACH
	ISC-324 TS-324 1⅝" 22 Galvalume® .24#	\$1.25
ENDLAP CINCH STRAP 	PART NO. SSR SYSTEM WIDTH GAUGE FINISH WT./EA.	PRICE PER EACH
	CS-324A TS-324 20¼" 18 Stainless .30#	\$4.00
	CS-324B TS-324 20¼" 18 Painted .30#	\$8.50

ACCESSORIES

	PART NO. SSR SYSTEM GAUGE LENGTH WT./EA.					PRICE PER EACH	
						Galvanized	COLOR
<p style="text-align: center;">GUTTER STRAP</p> 	GC-1	TS-324 / VS-216	18	0'-10"	.30#	\$1.75	\$4.75
	RS-1 TAPE SEAL - ROLLS	PART NO.	SIZE	LENGTH	CARTON QTY.	ROLL WT./EA.	PRICE PER EACH
 <p>RS-45 TAPE SEAL</p> 	RS-1	1 1/2" x 3/16" Triple Bead	30'-0"	5	3.6#	\$16.75	
	RS-45	3/8" x 3/32" Flat	45'-0"	40	1.5#	\$3.85	
Gray Butyl flat tape on waterproof release paper.							
TAPE SEAL - CUT-TO-LENGTH	PART NO.	SIZE	LENGTH	CARTON QTY.	WT./EA.	PRICE PER EACH	
	RS1-28	1 1/2" x 3/16" Triple Bead	28"	78	0.28#	\$1.40	
	RS1-22	1 1/2" x 1/8" Triple Bead	22"	78	0.15#	\$1.20	
	RS-8	1 1/2" x 3/16" Triple Bead	8"	180	0.08#	\$1.00	
	RS-3	1 1/2" x 3/16" Triple Bead	3"	360	0.03#	\$0.40	
Gray Butyl flat tape on waterproof release paper.							
TUBE CAULKING	TYPE	COLOR	TUBE SIZE	CARTON QTY.	WT./EA.	PRICE PER EACH	
 <p>10.3 oz. cartridge</p>	Polyurethane	White	10.3 oz	30	1.2#	\$8.75	
	Polyurethane	Gray	10.3 oz	30	1.2#	\$8.75	
	Polyurethane	Bronze	10.3 oz	30	1.2#	\$8.75	
	Polyurethane	Almond	10.3 oz	30	1.2#	\$8.75	
	Silicone	Clear	10.3 oz	30	1.2#	\$11.25	
	Non-Skinning Butyl	Gray	10.3 oz	30	1.2#	\$6.25	
HAND SEAMER / MODULARITY TOOL	DESCRIPTION				WT./EA.	PRICE PER EACH	
	TripleLok Hand Seamer for TS-324 / VS-216				22#	\$600.00	
	QuadLok Hand Seamer for TS-324 / VS-216				22#	\$615.00	
	Modularity Tool for TS-324 Panel Installation					\$6.00	
QuadLok Systems requires the use of both hand seamers above to achieve proper seam preparation for machine seaming.							
TOUCH-UP PAINT	DESCRIPTION					PRICE PER EACH	
	Matching Color, Panel Touch Up Paint					\$18.75	
	2 oz. Bottle						
					Silicone Polyester	\$32.75	
					Kynar		

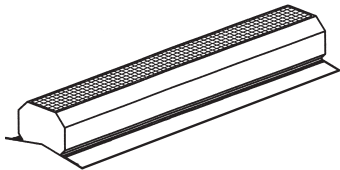
ACCESSORIES

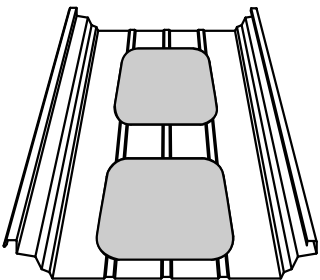
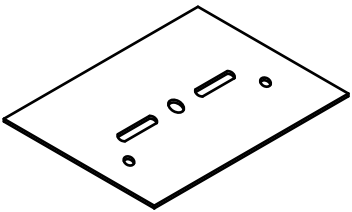
CONTINUOUS THROAT GRAVITY RIDGE VENTILATORS	DESCRIPTION				WT./EA.	PRICE PER EACH	
						GALVALUME®	WHITE
	9" Throat x 10' Long, 26 GA, w/ damper				207.0#	\$750.00	\$800.00
	12" Throat x 10' Long, 26 GA, w/ damper				223.0#	\$810.00	\$890.00
	All ventilators have bird screen and damper.						
	Pricing shown is for ventilators with flat skirts only. Included with each ventilator are splice plates, end skirts, and special rope sealant.						
	All ventilators will conform to roof slopes up to 6:12.						
For standard color ventilators other than Polar White, please inquire.							
For hardware required for adjustable ventilators, see page SSR-9.							
For chain operated ventilators, please inquire.							
VENTILATOR HARDWARE	DESCRIPTION				WT./EA.	PRICE PER EACH	
	Galvanized ³ / ₁₆ " Vent Cable					\$0.42 foot	
	Vent Pulley					\$8.75	
	¼" x 2" Eye Bolt w/ Nuts					\$0.45	
	Cable Clamps					\$0.60	
	Operator Handle					\$64.00	
LIGHT TRANSMITTING PANEL	TYPE	WIDTH	LENGTH	COLOR	WT.	PRICE PER EACH	
	Uninsulated	24"	10'-2"	GALVALUME®	32#	Please inquire	
	Uninsulated	24"	10'-2"	SMP Solar White	32#	Please inquire	
	Insulated	24"	10'-2"	GALVALUME®	38#	Please inquire	
	Insulated	24"	10'-2"	SMP Solar White	38#	Please inquire	
	Special Order Only - Please inquire for price and delivery. Non-cancellable once order is placed and panels are cut.						
BEARING PLATE	PART NO	FINISH	GAUGE	WT./EA.		PRICE PER EACH	
	HW-7500	Red-Oxide	16	0.32		\$2.55	
	Used with TS-324 and VS-216 For use when using rigid board insulation on top of purlins. Used with all clip types.						

ACCESSORIES

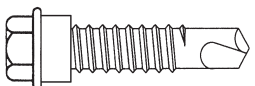
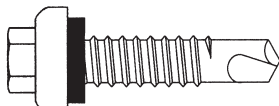
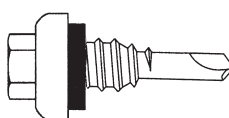
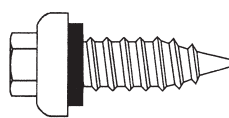
SELF-DRILLING CARBON STEEL FASTENERS  No Sealing Washer CLIP FASTENER	SIZE	LENGTH	TYPE	HEAD AF	WT./M	PRICE PER 1000	
						PLAIN	PAINTED
	#14	1½"	Driller	5/16"	20.0#	\$142.00	N/A
Fasteners sold in quantities of 250 only							
SELF-DRILLING CARBON STEEL SHOULDER FASTENERS  Fasteners sold in quantities of 250 only	SIZE	LENGTH	TYPE	HEAD AF	WT./M	PRICE PER 1000	
							PLAIN
	#14	1¼"	Driller	5/16"	17.5#	\$181.00	N/A
Fasteners sold in quantities of 250 only							
LONG-LIFE SELF-DRILLING FASTENERS  For attaching sheet to Cees and Zees.	SIZE	LENGTH	TYPE	HEAD AF	WT./M	PRICE PER 1000	
							PLAIN
	#14	1¼"	Driller	5/16"	19.2#	\$271.25	\$288.50
Fasteners sold in quantities of 250 only							
LONG-LIFE SELF-DRILLING FASTENERS  For attaching sheet to sheet.	SIZE	LENGTH	TYPE	HEAD AF	WT./M	PRICE PER 1000	
							PLAIN
	#14	7/8"	Laptek	5/16"	17.2#	\$187.75	\$204.75
Fasteners sold in quantities of 250 only							
LONG-LIFE SELF-TAPPING FASTENERS  Holes must be pre-drilled through all metal when using this type of fastener	SIZE	LENGTH	TYPE	HEAD AF	WT./M	PRICE PER 1000	
							PLAIN
	#17	1"	AB	5/16"	18.0#	\$274.50	\$291.50
Fasteners sold in quantities of 250 only							

ACCESSORIES

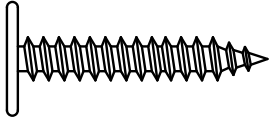
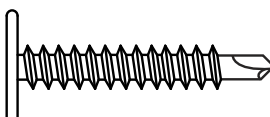
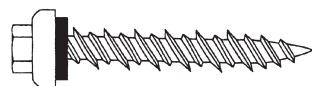
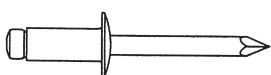
PHILLIPS HEAD CARBON STEEL PAN HEAD FASTENERS 	SIZE	LENGTH	TYPE	HEAD AF	WT./M	PRICE PER 1000	
						PLAIN	PAINTED
	#10	1"	A/B	Phillips	7.1#	\$57.00	N/A
Fasteners sold in quantities of 250 only							
PHILLIPS HEAD CARBON STEEL PAN HEAD FASTENERS 	SIZE	LENGTH	TYPE	HEAD AF	WT./M	PRICE PER 1000	
						PLAIN	PAINTED
	#10	1"	Driller	Phillips	7.0#	\$81.00	N/A
#12	1"	Driller	Phillips	8.0#	\$119.00	N/A	
Fasteners sold in quantities of 250 only							
LONG-LIFE METAL TO WOOD FASTENERS 	SIZE	LENGTH	TYPE	HEAD AF	WT./M	PLAIN	PAINTED
	#10	1"	WOODGRIP	5/16"	9.5#	\$217.50	\$234.50
	#10	1½"	WOODGRIP	5/16"	11.5#	\$299.50	\$316.50
	#10	2"	WOODGRIP	5/16"	14.0#	\$329.25	\$346.25
Fasteners sold in quantities of 250 only							
STAINLESS STEEL POP RIVETS 	SIZE	GRIP RANGE			WT./M	PRICE PER 1000	
						PLAIN	PAINTED
	1/8" diameter	.126" - .187"			2.8#	\$115.50	\$141.50
Fasteners sold in quantities of 250 only							
Body and mandrel are stainless steel							



HOUSTON PLANT
 17600 Badtke Road
 P.O. Box 609
 Hockley, TX 77447-0609
 1.866.749.2667 Toll Free
 281.213.6100 Tel.
 281.213.6101 Fax

BIRMINGHAM PLANT
 3387 Davey Allison Blvd.
 P.O. Box 3160
 Hueytown, AL 35023
 1.877.887.4247 Toll Free
 205.744.1561 Tel.
 205.744.1562 Fax

TRIM COLOR SELECTION CHART

	26 Ga.	24 Ga.	22 Ga.
CLEAR ACRYLIC COATED GALVALUME®	•	•	•
PREMIUM POLYESTER – PPOL			
Polar White	•	•	
SILICONE POLYESTER – SMP			
Light Stone	•		
Ash Gray	•		
Desert Sand	•		
Charcoal Gray	•		
Burnished Slate	•		
Saddle Tan	•		
Hawaii Blue	•		
Rustic Red	•		
Fern Green	•		
Burgundy	•		
Koko Brown	•		
Colony Green	•		
Crimson Red	•		
Aztec Gold	•		
Evergreen	•		
Coal Black	•		
Solar White	•	•	
KYNAR 500®			
Gallery Blue	•	•	
Regal Red	•	•	
Medium Bronze		•	
Snow White		•	
Slate Gray		•	
Almond		•	
Classic Green		•	
Brownstone		•	
Colonial Red		•	
Bone White		•	
Midnight Bronze		•	

FLAT SHEET PRICING

FLAT SHEETS

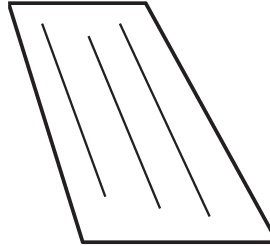

Finish	Gauge	Width	WT./FT.	PRICE PER FOOT
Clear Acrylic Coated GALVALUME®	26	41 9/16"	2.94#	\$6.25
SMP Standard Colors	26	41 9/16"	2.94#	\$7.90
PPOL Polar White	26	41 9/16"	2.94#	\$7.90
Kynar 500® Colors	26	41 9/16"	2.94#	\$8.18
PPOL Polar White / SMP Solar White	24	42 3/4"	3.86#	\$9.03
Kynar 500® Colors	24	42 3/4"	3.86#	\$10.13
Clear Acrylic Coated GALVALUME®	24	42 3/4"	3.86#	\$8.10
Clear Acrylic Coated GALVALUME®	22	42 3/4"	4.27#	\$11.50

NOTES:

1. Add \$35.00 for flat sheet wood skid/Maximum 100 flat sheets or 3000# per skid. Maximum 14' length.
2. Add \$50.00 for LTL crating/Maximum 100 flat sheets or 3000# per skid.
3. Strippable film is applied to all colored flat sheets.
4. Flat sheet lengths other than 10'-2" are available upon request. Minimum length 5', maximum length 14'-0". Flat sheet lengths over 14'-0" require special skid. Please inquire.
5. All flat sheets conform to ASTM A792, Grade 50 (Yield Strength 50,000 PSI).

TRIM

All trim is 26ga, unless noted.

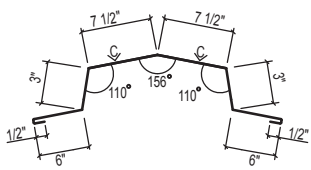
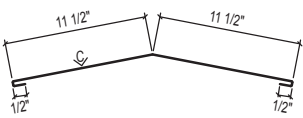
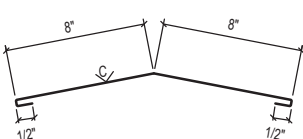
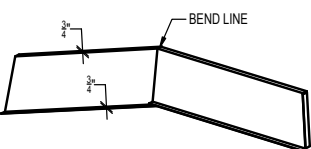
ITEM	DESCRIPTION			PRICE PER FOOT		
	PART NUMBER	LENGTH	WT./EA.	GALVALUME® 24 Gauge	SMP 24 Gauge	KYNAR 24 Gauge
RIDGE FLASHING  Specify roof slope	FL-200	10'-2"	29.75#	\$10.60	\$12.30	\$13.35
Used with TS-324 or VS-216						
RIDGE/HIP FLASHING  Specify roof slope	FL-56	10'-2"	17.40#	\$5.75	\$7.45	\$9.20
Used with TS-324 or VS-216						
RIDGE/HIP FLASHING  Specify roof slope	FL-303	10'-2"	12.35#	\$4.35	\$5.55	\$6.76
Used with TS324 or VS216						
FL-200 RIDGE END CAP  Specify roof slope	FL-201		1.60#	\$8.10 EA	\$8.45 EA	\$8.80 EA

TRIM

All trim is 26ga, unless noted.

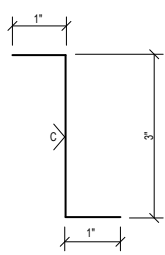
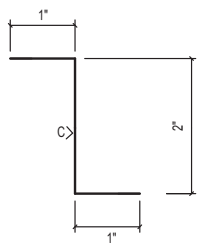
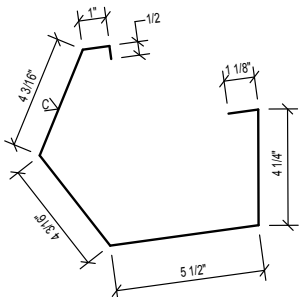
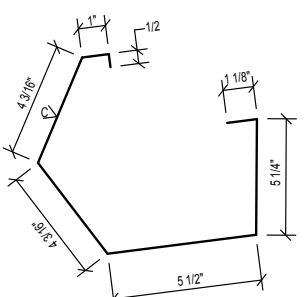
ITEM	DESCRIPTION			PRICE PER FOOT		
	PART NUMBER	LENGTH	WT./FT.	GALVALUME® 24 Gauge	SMP 24 Gauge	KYNAR 24 Gauge
Z CLOSURE 	FL-202	10'-2"	4.11#	\$1.68	\$1.93	\$2.09
	Used with TS-324 only					
Z CLOSURE 	FL-230	10'-2"	3.29#	\$1.42	\$1.62	\$1.74
	Used with VS-216 only					
SCULPTURED HANG-ON GUTTER 	FL-204		1.45#	\$5.29	\$6.74	\$8.23
	Used with TS-324 only Add \$6.50 per mitered piece Specify left or right					
GUTTER END CAP Specify roof slope	FL-205 (Specify left or right)		.22# EA	\$11.50 EA	\$13.50 EA	\$15.50 EA
SCULPTURED HANG-ON GUTTER 	FL-155		1.53#	\$5.49	\$7.01	\$8.58
	Used with VS-216 only Add \$6.50 per mitered piece Specify left or right					
GUTTER END CAP Specify roof slope	FL-156 (Specify left or right)		.22# EA	\$11.50 EA	\$13.50 EA	\$15.50 EA

TRIM

All trim is 26ga, unless noted.

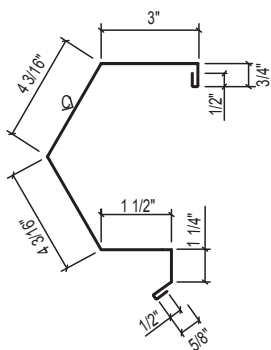
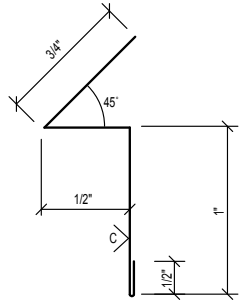
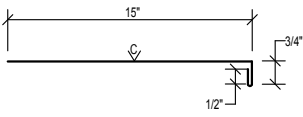
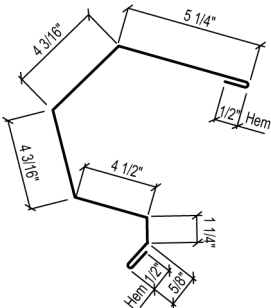
ITEM	DESCRIPTION		PRICE PER FOOT			
	PART NUMBER	WT./FT.	GALVALUME®	SMP	KYNAR	
SCULPTURED RAKE TRIM 	FL-206	1.17#	\$5.14	\$6.29	\$7.48	
	Used with TS-324 or VS-216 Add \$6.50 per mitered piece Specify left or right					
RAKE SLIDE TRIM 	FL-207	10'-2"	2.15#	\$1.27	\$1.47	\$1.67
	Used with TS-324 or VS-216 Floating Systems					
VARIABLE TERMINATION TRIM 	FL-208	10"-2"	11.74#	\$3.84	\$4.97	\$6.15
	Used with TS-324					
SCULPTURED HIGH SIDE EAVE TRIM 	FL-209	1.49#	\$5.62	\$7.00	\$8.42	
	Used with TS-324 or VS-216 Add \$6.50 per mitered piece Specify left or right					
EAVE END CAP Specify roof slope	FL-210	(Specify left or right)	.22# EA	\$11.50 EA	\$13.50 EA	\$15.50 EA

TRIM

All trim is 26ga, unless noted.

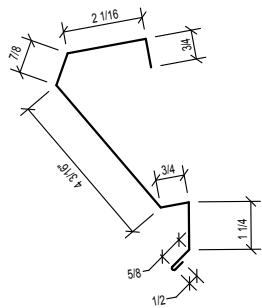
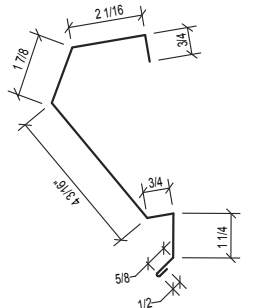
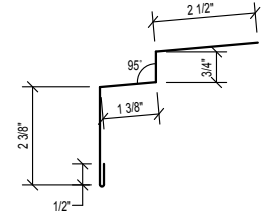
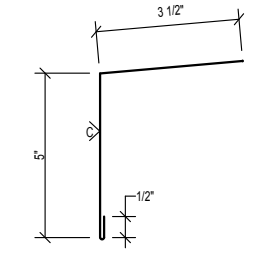
ITEM	DESCRIPTION		PRICE PER FOOT		
	PART NUMBER	WT./FT.	GALVALUME®	SMP	KYNAR
SCULPTURED LOW SIDE EAVE TRIM 	FL-211	.78#	\$3.66	\$4.43	\$5.22
	Used with TS-324				
EAVE END CAP Specify roof slope	FL-212 (Specify left or right)	.22# EA	\$11.50 EA	\$13.50 EA	\$15.50 EA
SCULPTURED LOW SIDE EAVE TRIM 	FL-190	.85#	\$3.87	\$4.70	\$5.57
	Used with VS-216 only				
EAVE END CAP Specify roof slope	FL-191 (Specify left or right)	.22# EA	\$11.50 EA	\$13.50 EA	\$15.50 EA
OFFSET PANEL CAP TRIM 	FL-213	.53#	\$2.42	\$2.94	\$3.48
	Used with PBR or A wall panels				
Specify roof slope					
FLAT EAVE TRIM 	FL-214	.50#	\$2.36	\$3.00	\$2.55
	Used with TS-324 or VS-216				
Specify roof slope					

TRIM

All trim is 26ga, unless noted.

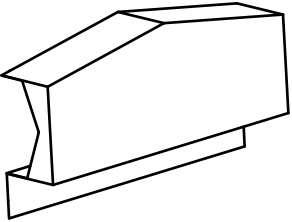
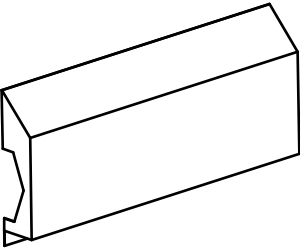
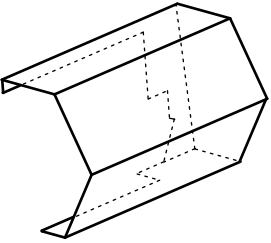
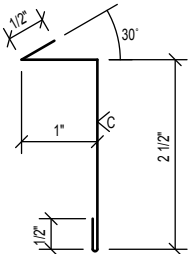
ITEM	DESCRIPTION		PRICE PER FOOT		
	PART NUMBER	WT./EA.	GALVALUME®	SMP	KYNAR
FIXED PEAK BOX  Specify roof slope	FL-203	3.14#	\$35.00 EA	\$35.50 EA	\$40.25 EA
	FL-216	6.10#	\$100.00 EA	\$104.75 EA	\$106.50 EA
FLOATING PEAK BOX  Specify roof slope	FL-217	1.80#	\$32.50 EA	\$33.50 EA	\$39.00 EA
	FL-218	.32#	\$1.91	\$2.13	\$2.27
SCULPTURED LOW EAVE CORNER BOX 	FL-218	.32#	\$1.91	\$2.13	\$2.27
	FL-218	.32#	\$1.91	\$2.13	\$2.27
COUNTER FLASH 	FL-218	.32#	\$1.91	\$2.13	\$2.27
	FL-218	.32#	\$1.91	\$2.13	\$2.27

TRIM

All trim is 26ga, unless noted.

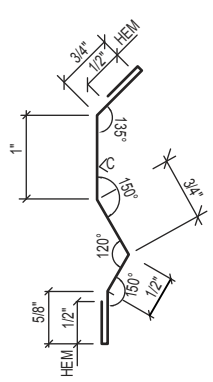
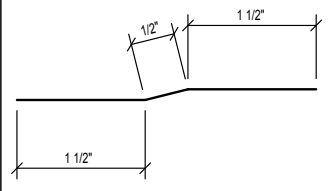
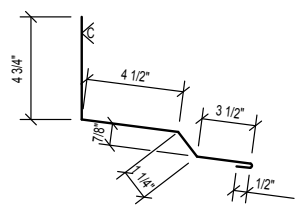
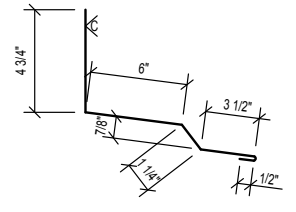
ITEM	DESCRIPTION			PRICE PER FOOT		
	PART NUMBER		WT./FT	GALVALUME® 24 Gauge	SMP 24 Gauge	KYNAR 24 Gauge
ALTERNATE COUNTERFLASH 	FL-219		.39#	\$2.62	\$2.85	\$2.99
						
OFFSET CLEAT	PART NUMBER	LENGTH	WT./EA.	GALVALUME® 24 Gauge	SMP 24 Gauge	KYNAR 24 Gauge
	FL-220	10'-2"	3.06#	\$1.29	N/A	N/A
HIGH SIDE PARAPET TRIM  <p>Specify roof slope</p>	PART NUMBER		WT./FT.	GALVALUME®	SMP	KYNAR
	FL-221		1.03#	\$3.84	\$4.85	\$5.90
	For roof slopes up to 5:12					
HIGH SIDE PARAPET TRIM  <p>Specify roof slope</p>	PART NUMBER		WT./FT.	GALVALUME®	SMP	KYNAR
	FL-222		1.14#	\$4.14	\$5.26	\$6.42
	For roof slopes greater than 5:12					

TRIM

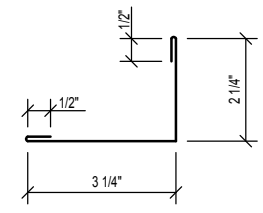
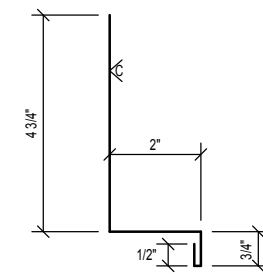
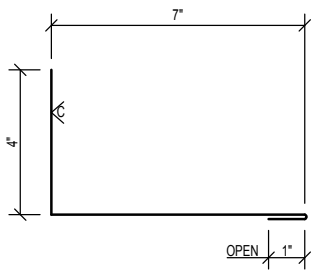
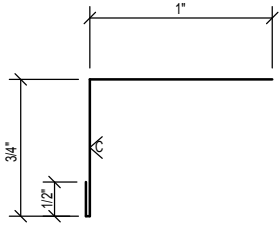
ITEM	DESCRIPTION			PRICE PER EACH		
LIGHT TRANSMITTING PANEL TRIM 	PART NUMBER	LENGTH	WEIGHT	GALVALUME®	SMP	KYNAR
	FL-226	10'-2"	4.62#	\$2.21	\$2.67	\$3.14
PARAPET RAKE (FIXED) 	PART NUMBER	LENGTH	WEIGHT	GALVALUME®	SMP	KYNAR
	FL-223	10'-2"	5.69#	\$2.34	\$2.90	\$3.48
PARAPET RAKE FLASH 	PART NUMBER	LENGTH	WEIGHT	GALVALUME®	SMP	KYNAR
	FL-224	10'-2"	8.54#	\$2.97	\$3.81	\$4.68
PARAPET RAKE CLEAT 	PART NUMBER	LENGTH	WEIGHT	GALVALUME®	SMP	KYNAR
	FL-225	10'-2"	1.60#	\$1.00	\$1.15	\$1.31

TRIM

All trim is 26ga, unless noted.

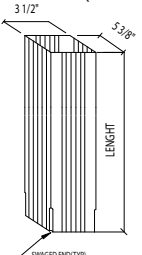
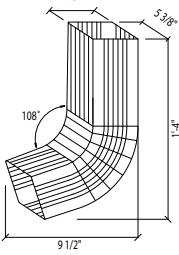
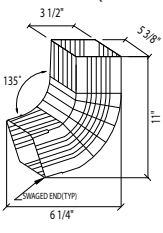
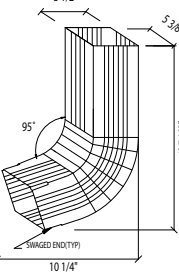
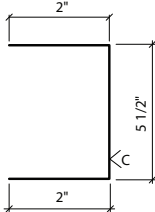
ITEM	DESCRIPTION		PRICE PER FOOT		
			GALVALUME®	SMP	KYNAR
ROLL FORMED DOWNSPOUT (STRAIGHT) 	PART NUMBER	WT./FT.			
	FL-100	1.23#	\$3.58	\$4.79	\$6.72
Available in 26 Gauge only					
ROLL FORMED DOWNSPOUT (72° KICKOUT) 	PART NUMBER	WT./EA.	GALVALUME®	SMP	KYNAR
	FL-101	2.29#	\$12.50 EA	\$17.25 EA	\$22.75 EA
Available in 26 Gauge only					
ROLL FORMED DOWNSPOUT (45° OFFSET) 	PART NUMBER	WT./EA.	GALVALUME®	SMP	KYNAR
	FL-102	1.25#	\$12.00 EA	\$16.75 EA	\$22.25 EA
Available in 26 Gauge only					
ROLL FORMED DOWNSPOUT (5° OFFSET) 	PART NUMBER	WT./EA.	GALVALUME®	SMP	KYNAR
	FL-103	2.86#	\$12.50 EA	\$17.25 EA	\$22.75 EA
Available in 26 Gauge only					
ROLL FORMED DOWNSPOUT STRAP 	PART NUMBER	WT./EA.	GALVALUME®	SMP	KYNAR
	FL-104	.08#	\$5.25 EA	\$6.00 EA	\$6.25 EA

TRIM

All trim is 26ga, unless noted.

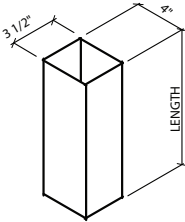
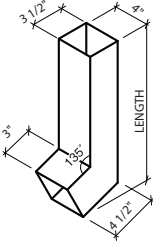
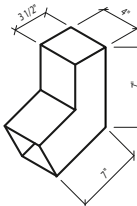
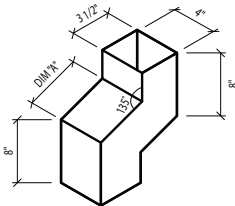
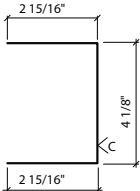
ITEM	DESCRIPTION			PRICE PER FOOT, unless noted		
	PART NUMBER		WT./FT.	Acrylic Coated GALVALUME®	SMP Colors	Kynar 500® Colors
DOWNSPOUT (STRAIGHT) 						
	FL-40		1.15#	\$6.28	\$8.21	\$11.58
DOWNSPOUT (W/45° ELBOW) 						
	FL-41		1.15#	\$6.91	\$8.49	\$10.11
DOWNSPOUT ELBOW 	PART NUMBER	LENGTH	WT./EA.	Acrylic Coated GALVALUME®	SMP Colors	Kynar 500® Colors
	FL-42 (45°)	7"	1.40#	\$24.00 EA.	\$26.25 EA.	\$28.25 EA.
	FL-43 (90°)	7"	1.40#	\$24.00 EA.	\$26.25 EA.	\$28.25 EA.
DOWNSPOUT OFFSET 	PART NUMBER	DIM. A	WT./FT.	Acrylic Coated GALVALUME®	SMP Colors	Kynar 500® Colors
	FL-44A	6" - 5'-0"	1.15#	\$52.50 EA.	\$58.25 EA.	\$69.25 EA.
	FL-44B	5'1" - 10'-0"	1.15#	\$73.75 EA.	\$83.75 EA.	\$94.81 EA.
DOWNSPOUT STRAP 	PART NUMBER	LENGTH	WT./EA.	Acrylic Coated GALVALUME®	SMP Colors	Kynar 500® Colors
	FL-45	1"	0.08#	\$5.25 EA.	\$6.00 EA.	\$6.25 EA.



HOUSTON PLANT
 17600 Badtke Road
 P.O. Box 609
 Hockley, TX 77447-0609
 1.866.749.2667 Toll Free
 281.213.6100 Tel.
 281.213.6101 Fax

BIRMINGHAM PLANT
 3387 Davey Allison Blvd.
 P.O. Box 3160
 Hueytown, AL 35023
 1.877.887.4247 Toll Free
 205.744.1561 Tel.
 205.744.1562 Fax

TRIM PRICING INFO / SPECIAL TRIM PRICING

TRIM PRICING:

1. 24 ga. & 22ga. GALVALUME, 24 ga. PPOL Polar White & 24 ga. Kynar 500 colors available at an additional cost. (See Page SSR-15 for available trim color selections.)
2. Prices do not include standard packaging.

PACKAGING COST:

1. Trim with girth greater than 15" 20 pieces/carton
2. Trim with girth less than 15" 50 pieces/carton
3. Downspouts..... 12/carton
4. Standard Packaging: 500# test cardboard with protective interleaf and metal bands \$22.50 (10') \$40.00 (21')
5. Paper wrap only (For customer pick-up only) \$5.00 (10') \$10.00 (21')
6. LTL Packaging: 500# test cardboard with protective interleaf, wood blocks and metal bands \$50.00 (10') \$75.00 (21')
7. Plywood crating \$20.00/linear foot
8. Special Packaging Please Inquire.

DELIVERY:

All SBS stocked trim colors and gauges (See Page SSR-15 for available trim color selections) Approximately 3 to 5 Working Days

SPECIAL TRIM PRICING

FORMULA FOR PRICING SPECIAL TRIM

Use the following formula to calculate the Price Per Foot of Trim:

Girth of Material x Price per Inch of Girth + Price per Number of Breaks

Price per Inch of Girth	- 26 Gauge (GALVALUME)	~ \$0.24
	- 26 Gauge (SMP COLOR)	~ \$0.32
	- 26 Gauge (KYNAR COLOR)	~ \$0.37 (See Page SSR-15 for Limited Color Selections)
	- 24 Gauge (GALVALUME)	~ \$0.27
	- 24 Gauge (SMP COLOR)	~ \$0.36
	- 24 Gauge (KYNAR COLOR)	~ \$0.43
	- 22 Gauge (GALVALUME)	~ \$0.42
Price per Break (Hem equals two breaks)		~ \$0.14

1. All trim to be 26 gauge material unless noted otherwise on customer drawing or sketch.
2. Customer drawing or sketch of special trim must be in our possession for order to be processed.
3. Specify the side with the finish color.
4. If more than one special trim is required, number each piece SF1, SF2, SF3, etc.
5. Tapered trim requirements: \$25.00 Set-Up charge per section - NO EXCEPTIONS. Drawings must be furnished by customer and be "shop ready".
6. 5'-0 minimum length will be charged.

SEAM TYPES

TS-324 TRIPLELOK™ SEAM

The TripleLok Seam requires preliminary seaming of the roof panel with the manual TripleLok seaming tool at the starting eave and/or ridge end of the roof panel, at every clip and at the endlaps followed by seaming the full length of the roof panels with the motor seaming machine, except endlaps. Endlaps are to be hand seamed only.

The motor seaming machine must be fitted with the TripleLok seaming rolls.

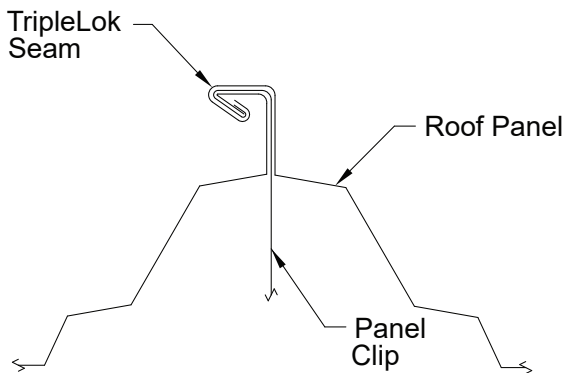

VS-216 TRIPLELOK™ SEAM

The TripleLok Seam requires preliminary seaming of the roof panel with the manual TripleLok seaming tool at the starting eave and/or ridge end of the roof panel, at every clip and at the endlaps followed by seaming the full length of the roof panels with the motor seaming machine, except endlaps. Endlaps are to be hand seamed only.

The motor seaming machine must be fitted with the TripleLok seaming rolls.

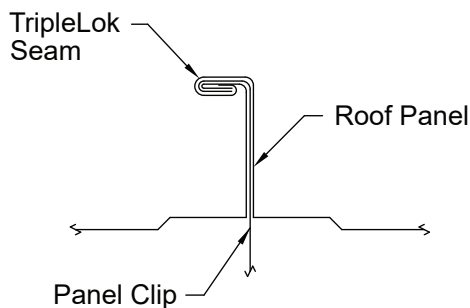

TS-324 QUADLOK™ SEAM

The QuadLok Seam requires that the roof panels be previously TripleLok machine seamed. The QuadLok Seam requires additional manual seaming of the roof panel with the manual QuadLok seaming tool at the starting eave and/or ridge end of the roof panel and at the endlaps followed by seaming the full length of the roof panels with the motor seaming machine, except endlaps. Endlaps are to be hand seamed only.

The motor seaming machine must be fitted with the QuadLok Seaming rolls.

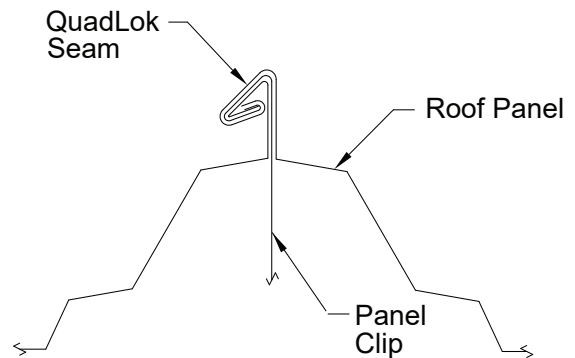

VS-216 QUADLOK™ SEAM

The QuadLok Seam requires that the roof panels be previously TripleLok machine seamed. The QuadLok Seam requires additional manual seaming of the roof panel with the manual QuadLok seaming tool at the starting eave and/or ridge end of the roof panel and at the endlaps followed by seaming the full length of the roof panels with the motor seaming machine, except endlaps. Endlaps are to be hand seamed only.

The motor seaming machine must be fitted with the QuadLok Seaming rolls.

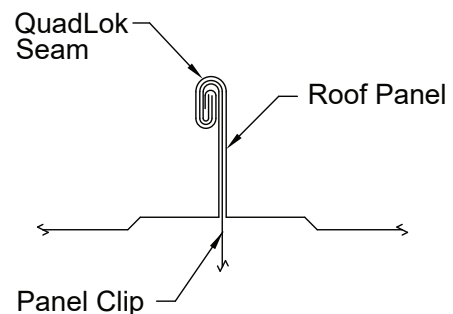

Manual hand seaming tools are available for purchase on Page SSR-10
Seaming machines are available for rental at www.schulteseamers.com and are financial responsibility of the renting party.